

RoHS2.0
Compliant

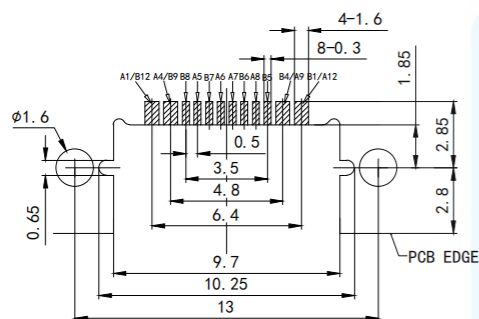

RECOMMEND P. C. B LAYOUT
TOLERANCE UNSPECIFIED ± 0.05

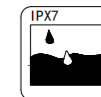
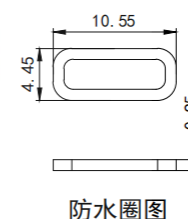
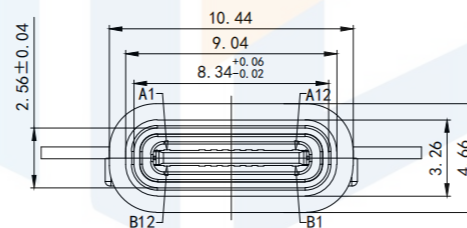
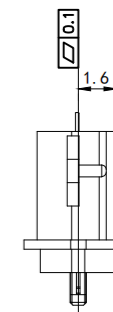
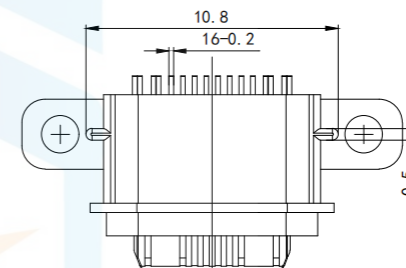
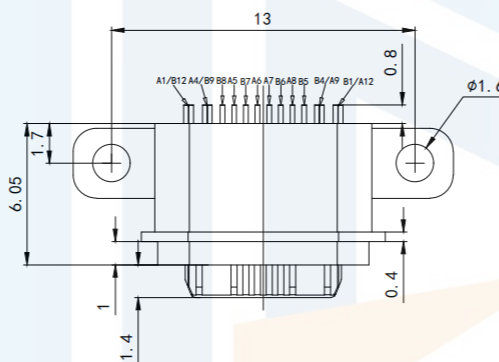
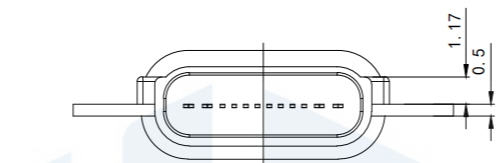

NOTES:

SPECIFICATION:

- CURRENT RATING: 3.0 A
- VOLTAGE RATING: 3.0 V
- VBUS & GND PINS AND OTHER PINS: 40mΩ/PIN MAX
SHIELD: 50mΩ/MAX LLGR MAX. CHANGE OF ALL PINS: 10Ωm
- INSULATION RESISTANCE: 100MΩ MIN
- DIELECTRIC WITHSTAND VOLTAGE, AC 100V FOR 1MINUTE
- INSERTION FORCE: 0.5~2.0kgf
- UNMATING FORCE: 0.8-2.0kgf
- DURABILITY: 10000 CYCLES
- OPERATING TEMPERATURE: -35° C~+85° C
- THE PEAK TEMPERATURE ON THE BOARD SHALL BE MAINTAINED FOR 10 SECONDS AT 210-230° C
- WATERPROOF: IP-X7.

TOLERANCE X. XXX ± 0.05 X. XX ± 0.15 X. X ± 0.20 X. ± 0.30 ANGLE $\pm 5.0^\circ$		东莞市恒祺电子科技有限公司 Dongguan Hengqi Electronic Technology Co., Ltd	
		https://www.hq-dz.com phone:15812872448	
PROTECTON 	DRAWN: CHECKED: APPROVED:	TITLE: TYPE C 16P 防水母座沉板1.6 L=6.05mm(外壳带螺丝孔)粉末冶金	
		PART NO: TYPE-C16P-CB216FS DRAWING NO: 13*4.66*6.05	
		DATE: 18-10-08	UNIT: mm
		DATE: 18-10-08	SCALE: FULL
		DATE: 18-10-08	SIZE: A4